

5300 Series

Relief Valves

400 to 10,500 psig (28 – 724 bar)



Features

- Zero leakage up to 95% of cracking pressure
- No chatter or squeal
- Positive reseal at a high percentage of cracking pressure
- No pressure rise with increasing flow
- Externally adjustable
- PED certifications and CE marking available for most models

Technical Data

Body Construction Materials	Brass, 303 or 316 stainless steel
O-ring Materials	Buna N, neoprene, and Viton®
Poppet Materials	<ul style="list-style-type: none"> • Liquid service: CRES 440C • Gas service to 3074 psi: PCTFE • Gas service above 3074 psi: Polyimide (VespeI®)
Retainer Stem	303 stainless steel
Seat Material	17-4 PH stainless steel
Spring Material	17-7 PH stainless steel
Backup Rings	Teflon®
Operating Pressure	400 to 10,500 psig (28 to 724 bar); specify cracking pressure
Proof Pressure	<ul style="list-style-type: none"> • Gas: 4500 psig (PCTFE); 10,500 psig (Polyimide) • Liquid: 16,000 psig
Burst Pressure	<ul style="list-style-type: none"> • Brass: over 30,000 psig (2068 bar) • Stainless steel: over 40,000 psig (2758 bar)
Temperature Range	-65° F to +350° F (-54° C to +177° F) <i>Based on O-ring & body material, see "How to Order"</i>
Connection Sizes	<ul style="list-style-type: none"> • ¼" to ½" female pipe • ¼" to 1" female tube

Note: Proper filtration is recommended to prevent damage to sealing surfaces.

How it Works

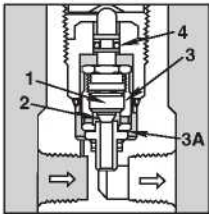

Closed

In the closed position, the poppet (1) is impressed against the orifice (2) by the spring and seals of the orifice. This impression is limited by the poppet retainer (3) which bottoms on the shoulder of the orifice nozzle unit at point 3A. As system pressure rises, pressure within the poppet retainer and above the poppet increases, effecting further sealing efficiency. As pressure rises above normal operating pressure, the poppet retainer (3) moves upward overcoming breakaway friction of the O-ring seal (4) before the preset cracking pressure is reached. This insures extremely precise cracking pressure accuracy.

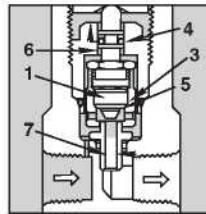

Cracking

When system pressure rises above the cracking pressure, the force at area 6 is increased and overcomes the preset spring force, permitting the poppet retainer (3) to continue its upward movement and lift the poppet (1) away from the orifice (5), permitting flow through the orifice passage (7).

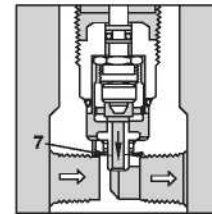

Open

Under conditions of flow, back pressure in the orifice nozzle (7) reduces the effective downward force on the poppet, which allows the poppet retainer unit to open further, providing increased flow with little or no increase in pressure. Where the valve is used as a sequence or priority valve, the downstream pressure buildup permits the poppet to open fully, allowing flow with minimum pressure drop.

relief valves



22 Sarum Complex,
Salisbury Road,
Uxbridge,
Middlesex
UB8 2RZ

ISO9001 & RS00209

TAMO
LIMITED

VALVES, SWITCHES, INSTRUMENTATION
AND SYSTEMS FOR
PRESSURE, FLOW AND
TEMPERATURE APPLICATIONS

Tel: 01895 200015 Fax: 01895 252205
E-Mail: info@tamo.co.uk Website: www.tamo.co.uk

5300 Series

Cracking Pressure Tolerance: $\pm 5\%$

Flow at cracking pressure: Gas = 5cc/min
Teflon® seals = 0.02 scfm

Reseal pressure

Crack Pressure Reseal Pressures

400–599 psi	80% of C.P.
600–899 psi	85% of C.P.
900–5999 psi	90% of C.P.
6000 psi & greater	95% of C.P.

Leakage at reseal pressure

Gas	Ascending pressure = zero to 95% of cracking pressure
	Descending pressure = zero at reseal
Liquid	Ascending pressure = 5cc/min maximum to 95% of cracking pressure
	Descending pressure = 15cc/min maximum at reseal

Dimensions (inches)

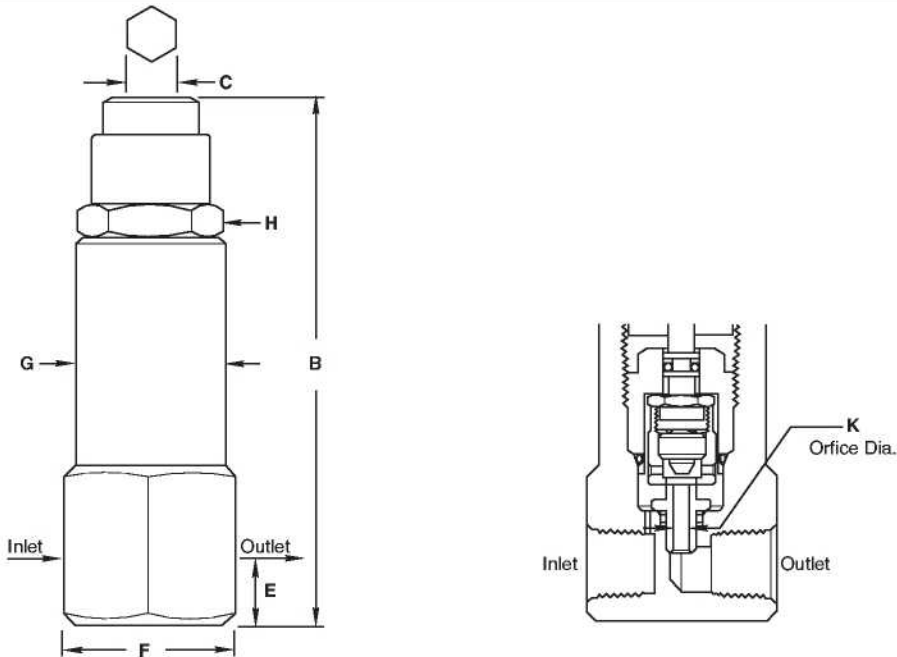

Tube Size	C.P. Range (PSI)	B Max.	C Hex	E	F Hex	G Dia.	H Hex	K Dia.	Weight (lbs)	
									Brass	Stainless Steel
1/4", 3/8"	420–3074	4.88	1/2	0.52	1.63	1.38	1.25	0.125	1.6	1.5
	3075–10,500	5.78	3/8	0.52	1.63	1.38	1.25	0.125	1.8	1.7
1/2"	420–3074	4.88	1/2	0.70	1.88	1.38	1.25	0.125	1.6	1.5
	3075–10,500	5.78	3/8	0.70	1.88	1.38	1.25	0.125	1.8	1.7
3/4"	400–2299	7.01	5/16	0.94	2.50	1.75	1.50	1.88	—	—
	2300–10,500	8.48	1/2	0.94	2.50	1.75	1.50	1.88	—	—
1"	400–2299	7.01	5/16	0.94	3.00	1.75	1.50	1.88	—	—
	2300–10,500	8.48	1/2	0.94	3.00	1.75	1.50	1.88	—	—

Pipe Size	C.P. Range (PSI)	B Max.	C Hex	E	F Hex	G Dia.	H Hex	K Dia.	Weight (lbs)	
									Brass	Stainless Steel
1/4"	420–3074	4.88	1/2	0.52	1.50	1.38	1.25	0.125	1.6	1.5
	3075–10,500	5.78	3/8	0.52	1.50	1.38	1.25	0.125	1.8	1.7
1/2"	400–2299	7.01	5/16	0.82	2.00	1.75	1.50	0.188	3.2	3.0
	2300–10,500	8.48	1/2	0.82	2.00	1.75	1.50	0.188	3.7	3.5

5300 Series

Typical Flow Curves

5300-4PP with Hydraulic Fluid
MIL-H-5606

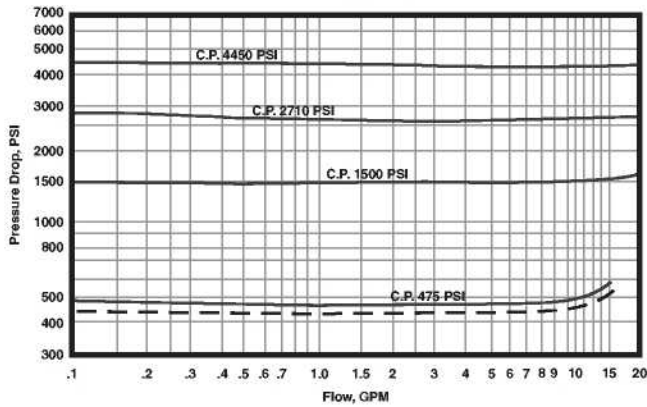

5300-4PP with Air

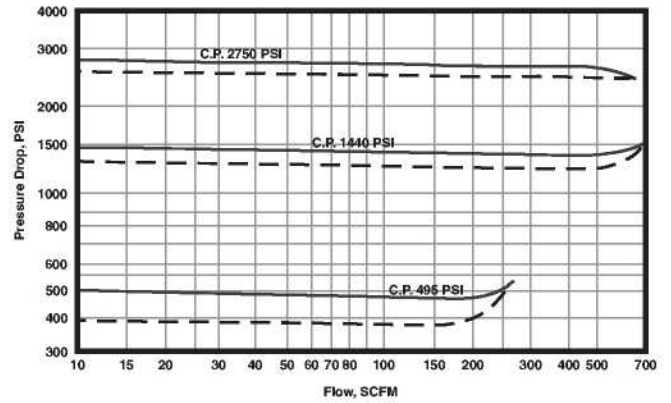

5300-8BB, 5300-2BB with Hydraulic Fluid
MIL-H-5606

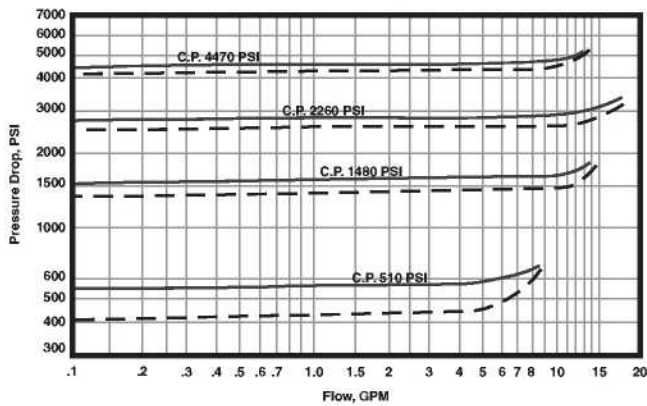

5300-8PP, 5300-2PP with Air

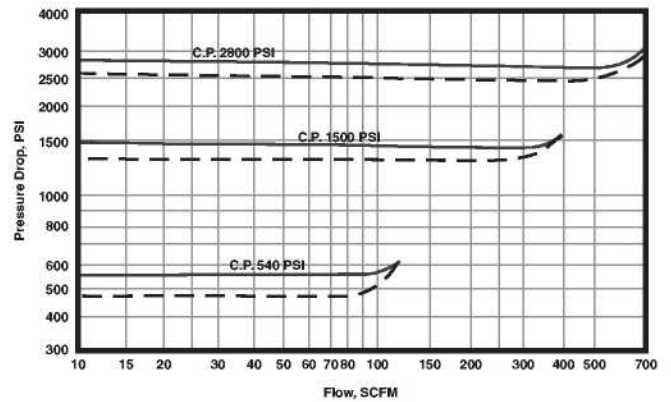

Increasing flow ———

Decreasing flow - - - -

How to Order

L 53 49 B - 4 PP (L) - 500

VARIATION*

- L** Liquid service, CRES 440C poppet
- B** 2000 psi maximum with liquids
Gas service:
Up to 3,024 psi: PCTFE poppet
3,024 psi and greater: Polyimide (Vespel®) poppet

O-RING MATERIAL & TEMPERATURE

- 32** Viton®, -20° F to +350° F (-29°C to +177°C)
- 33** Neoprene, -20° F to +240° F (-29°C to +116°C)
- 49** Buna N, -65° F to +250° F (-54°C to +121°C)

BODY MATERIAL

- B** Brass†
- T** 303 stainless steel†
- T1** 316 stainless steel

CRACKING PRESSURE

Specify cracking pressure setting in psig
(400 – 10,500 psig)

SPECIAL CHARACTERISTICS

- L** Lockwire (otherwise leave blank)

CONNECTIONS

- P** Female pipe
- B** Female tube, AND10050
- K** Male British parallel pipe
- L** Female British parallel pipe
- G** Aminco, union
- V** NASA MC240

VALVE SIZE

Pipe sizes in 1/8" increments
Tube sizes in 1/16" increments

- 2** 1/4" pipe
- 4** 1/2" pipe; 1/4" tube
- 6** 3/8" tube
- 8** 1/2" tube
- 12** 3/4" tube
- 16** 1" tube

* Blank if not required

† For PED applications, bodies are limited to a maximum temperature use of +100° F (+38° C)

To specify PED certification, add PED prefix to the part number.

Back pressure: Any back pressure above atmosphere reduces the cracking pressure by 0.35 psi for each 1.0 psi of back pressure.

Repair Kits

In normal service, the only part(s) which may require replacement is(are) the seal(s). A repair kit may be ordered by placing a ' K/' in front of the complete part number (i.e. K/5349B-4PP).

Cracking Pressure Spring Ranges

Consult factory for replacement spring part numbers

Dash No. (Valve Size)	C.P. Range	Dash No. (Valve Size)	C.P. Range
	400-599		420-589
	600-899		590-839
	900-1299		840-1179
-4PP (1/2")	1300-1799	-2PP (1/4")	1180-1574
-12BB (3/4")	1800-2299	-4BB (1/4")	1575-1899
-16BB (1")	2300-3299	-6BB (3/8")	1900-2449
	3300-6999	-8BB (1/2")	2450-3074
	7000-10,500		3075-3999
			4000-7399
			7800-10,500

TAMO LIMITED

22 Sarum Complex
Salisbury Road
Uxbridge
Middlesex
UB8 2RZ

TEL: 01895 200015 FAX: 01895 252205
E-Mail: info@tamo.co.uk Website: www.tamo.co.uk

Viton® is a registered trademark of DuPont Dow Elastomers.
Vespel® is a registered trademark of E.I. du Pont de Nemours and Company.
Teflon® is a registered trademark of the DuPont Company.

For Your Safety

It is solely the responsibility of the system designer and user to select products suitable for their specific application requirements and to ensure proper installation, operation, and maintenance of these products. Material compatibility, product ratings and application details should be considered in the selection. Improper selection or use of products described herein can cause personal injury or property damage.