

# Mark 70 Series

CRN Registration Number Available

## Sliding Gate Control Valves

The Mark 70 Series is a line of pneumatically-operated diaphragm control valves that combine multiple spring actuators with the precision of Jordan Valve's advanced sliding gate seat for closer control and greater accuracy.

Jordan's unique sliding gate control valve trim teams up with pressure, temperature pH, level, or flow controllers for fast response, long term reliability, and high levels of accuracy on steam, gas, liquid and chemical services.

Consisting of a modulating disc and stationary plate, the sliding gate seat components are slotted with multiple orifices that align to provide the precise flow needed to maintain the process requirements. The valve strokes in a fraction of the travel required by conventional control valves for rapid correction of any deviation from the process setpoint.

This brochure includes the following Series:

- **MK70:** a line of pneumatically-operated diaphragm control valves that combine multiple spring actuators with the precision of Jordan Valve's advanced sliding gate for closer control and greater metering accuracy
- **MK70PG:** a pump governor with its control port connected to the pump discharge line. The valve throttles to maintain a constant pump discharge by controlling the steam flow to the pump.
- **MK701/702:** for higher capacity requirements.
- **MK707:** features an equal percentage flow characteristic.
- **MK711:** a linear control valve in sizes up to 6" with Cv's to 395
- **MK74:** controls fugitive emissions while reducing the risks associated with toxic, corrosive, explosive and high temperature fluids



### FEATURES

- Totally enclosed multi-spring actuator – minimizes deadband and is field reversible without the use of special tools or additional parts
- Compact design and simple construction – allows fast, simple installation and easy maintenance
- Sliding gate seats provide:
  - Straight-through flow for reduced turbulence and quiet operation
  - Short stroke for fast response and accurate control
  - Easily interchangeable Cv's
  - Tight shutoff due to overlap of seat closure area
- Stem packing is four times deeper than stem travel – for greater protection against leakage

## SPECIFICATIONS

**Sizes:** (note: 1/4" & 3/8" sizes use 1/2" body with reducers)

- Mark 70/70PG: 1/4" through 2" (DN8 through DN50)
- Mark 707: 1/2" through 6" (DN8 through DN150)
- Mark 711: 2-1/2" through 6" (DN65 through DN150)

### End Connections

- Threaded (NPT, BSPT, BSPP – through 2" sizes/DN50)
- ANSI Flanges (150#, 300#)
- DIN Flanges (PN10/16, PN25/40)

### Body Materials

- Ductile Iron
- Bronze (1/2" – 2"/DN15 - DN50)
- Carbon Steel (WCB)
- Stainless Steel (CF8M)

### Trim Materials

- 303SS for CI and DI body valves
- 316SS for SS body valves

### Seat Materials

- Jorcote on SST – standard

**Yoke Material:** Cast Iron

**Actuator:** Steel

**Diaphragm:** Buna-N (standard to 200°F/93°C)

**Stem Packing:** spring-loaded Teflon (to 450°F/232°C); Graphite (to 1200°F/649°C)

**Service:** Steam, water, oil, gas, air and chemicals

**Shutoff:** ANSI Class IV

### Ranges

- Mark 70/707/711: 3-15, 3-9, 9-15, 6-30 psi (0,21-1,03; 0,21-0,62; 0,62-1,03; 0,41-2,07 bar)
- Mark 70PG: consult factory for ranges

### Action

- Direct (air signal closes valve)
- Reverse (air signal opens valve)

**Positioner:** side or top-mounted positioners are available to overcome the normal hysteresis for a control valve and actuator, and to ensure that the valve stem position is always directly proportional to the control valve command signal. See the Positioner section for more details.

### Rangeability

- MK70: 1/2" – 1-1/2", 100:1
- MK70: 2", >200:1
- MK711: 2-1/2" – 3", >200:1
- MK711: 4" – 6", 100:1
- MK707: all sizes 100:1

**Cv VALUES AND MAXIMUM ALLOWABLE DIFFERENTIAL PRESSURE RATINGS**

- Mark 70

Flow Coefficient		Valve Size	Seat Material	Maximum Differential Pressure (PSI)									
Cv	Kv			Std. 35M Actuator		35M with Positioner		Optional 55M Actuator		55M with Positioner		Optional 85M Actuator	
				PSI	BAR	PSI	BAR	PSI	BAR	PSI	BAR	PSI	BAR
2.5 or 4.4	2,2 or 3,8	1/2" & 3/4" (DN15 & 20)	SST	125	8,6	175	12,1	175	12,1	175	12,1	175	12,1
			Jorcote	250	17,2	500	34,5	350	24,1	700	48,3	550	37,9
6.4 or 9.5	5,5 or 8,2	1" & 1-1/4" (DN25 & 32)	SST	100	6,9	150	10,3	150	10,3	150	10,3	150	10,3
			Jorcote	150	10,3	300	20,7	225	15,5	425	29,3	350	24,1
15	12,9	1-1/2" (DN40)	SST	75	5,2	125	8,6	100	6,9	125	8,6	125	8,6
			Jorcote	125	8,6	250	17,2	175	12,1	350	24,1	275	19,0
25 or 30	21,5 or 25,8	2" (DN50)	SST	75	5,2	125	8,6	100	6,9	125	8,6	125	8,6
			Jorcote	125	8,6	250	17,2	175	12,1	350	24,1	275	19,0

Based on 45 psi (3,1 bar) to actuator or psi

- Mark 711 — Standard Actuator: 2-1/2" – 3": 55M;  
4" – 6" 85M

Flow Coefficient Cv (Kv)	Valve Size	Seat Material	Maximum ΔP, PSI* (BAR)	
			Standard	w/Positioner
85 (73)	2-1/2" (DN65)	Jorcote	50 (3,5)	275 (19)
130 (112)	3" (DN80)	Jorcote	50 (3,5)	275 (19)
200 (172)	4" (DN100)	Jorcote	50 (3,5)	325 (22)
395 (340)	6" (DN150)	Jorcote	50 (3,5)	225 (16)

\* Higher ΔP's available with optional larger actuators

- Mark 707 — Standard Actuator: 1/2" – 2": 35M;  
2" - 8": 55M

Flow Coefficient Cv (Kv)	Valve Size	Seat Material	Maximum ΔP* PSI (BAR)	
			Standard Actuator	w/Positioner
2.5 (2,2)	1/2" (DN15)	Jorcote	250 (17,2)	500 (34,5)
4.4, 6.4 or 9.5 (3,8; 5,5; or 8,2)	3/4" (DN20)	Jorcote	150 (10,3)	300 (20,7)
11.5 (9,9)	1" (DN25)	SST	100 (6,9)	175 (6,9)
		Jorcote	150 (10,3)	300 (13,8)
13 (11,2)	1-1/4" (DN32)	SST	100 (6,9)	175 (6,9)
		Jorcote	150 (10,3)	300 (23,8)
22 (18,9)	1-1/2" (DN40)	SST	100 (6,9)	150 (6,9)
		Jorcote	150 (10,3)	150 (6,9)
34 (29,2)	2" (DN50)	SST	100 (6,9)	150 (6,9)
		Jorcote	150 (10,3)	150 (6,9)
60 (51,6)	2-1/2" (DN65)	Jorcote	50 (3,5)	275 (19,0)
80 (68,8)	3" (DN80)	Jorcote	50 (3,5)	275 (19,0)
130 (112)	4" (DN100)	Jorcote	50 (3,5)	225 (15,5)
230 (198)	6" (DN150)	Jorcote	50 (3,5)	150 (6,9)

**Low Flow:** reduced Cv's can be used in any size valve as long as it is a smaller value than is standard for that size. In addition, these low flow Cv's can be provided:

1.6	0.84	0.42	0.21	0.08	0.04
0,02	0,008	0,004	0,002	0,0008 (N/A in 316SS)	

## MARK 70 SLIDING GATE CONTROL VALVES

### MAXIMUM WORKING PRESSURES & TEMPERATURES

- Mark 70 & Mark 707 (1/2" – 2") (DN15 - DN50)

Maximum Pressure @ 100°F, PSI/°F												
Packing	DI Body			BRZ Body			CS Body			SST Body		
	150#	300#	TE	150#	300#	TE	150#	300#	TE	150#	300#	TE
Any	250	640	988	225	500	500	285	740	1480	275	720	1440
Pressure @ Maximum Temperature, PSI/°F												
TEF	170/450	495/450	808/450	150/450	325/450	325/450	170/450	600/450	1200/450	170/450	480/450	955/450
GRAF	125/650	450/650	715/650	150/500	325/500	325/500	125/650	535/650	1075/650	125/650	445/650	890/650

Maximum Pressure @ 38°C, BAR/°												
Packing	DI Body			BRZ Body			CS Body			SST Body		
	150#	300#	TE	150#	300#	TE	150#	300#	TE	150#	300#	TE
Any	17	44	68	16	34	34	20	51	102	19	50	99
Pressure @ Maximum Temperature, PSI/°C												
TEF	12/232	34/232	56/232	10/232	22/232	22/232	12/232	41/232	83/232	12/232	33/232	66/232
GRAF	9/343	31/343	49/343	10/343	22/343	22/343	9/343	37/343	74/343	9/343	31/343	61/343

- Mark 711 & Mark 707 (2-1/2" – 6") (DN65 - DN150\_)

Maximum Pressure @ 100°F, PSI/°F												
Packing	DI Body			BRZ Body			CS Body			SST Body		
	150#	300#	TE	150#	300#	TE	150#	300#	TE	150#	300#	TE
Any	250	640	—	—	—	—	285	740	—	275	720	—
Pressure @ Maximum Temperature, PSI/°F												
TEF	170/450	495/450	—	150/450	325/450	—	170/450	600/450	—	170/450	480/450	—
GRAF	125/650	450/650	—	150/500	325/500	—	125/650	535/650	—	125/650	445/650	—

Maximum Pressure @ 38°C, BAR/°												
Packing	DI Body			BRZ Body			CS Body			SST Body		
	150#	300#	TE	150#	300#	TE	150#	300#	TE	150#	300#	TE
Any	17	44	—	—	—	—	20	51	—	19	50	—
Pressure @ Maximum Temperature, PSI/°C												
TEF	12/232	34/232	—	10/232	22/232	—	12/232	41/232	—	12/232	33/232	—
GRAF	9/343	31/343	—	10/343	22/343	—	9/343	37/343	—	9/343	31/343	—

**PRESSURE-TEMPERATURE CHARTS – MK70, MK74**

- Ductile Iron

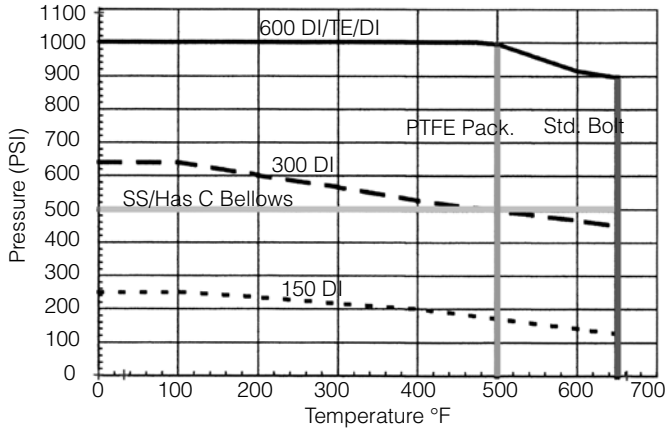

- Stainless Steel

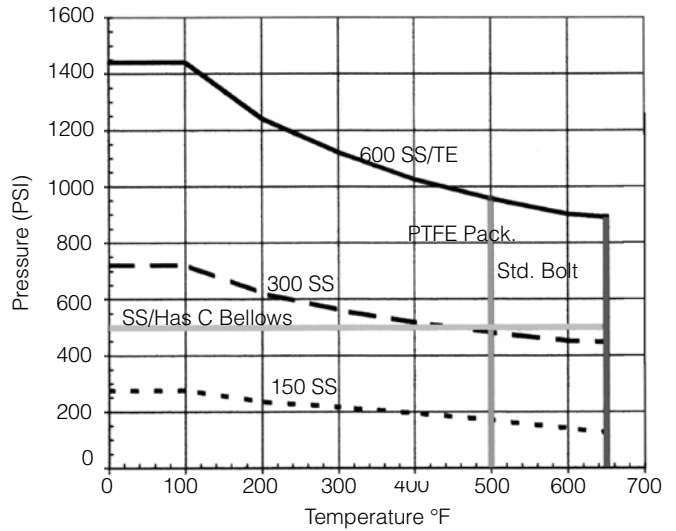

- Carbon Steel

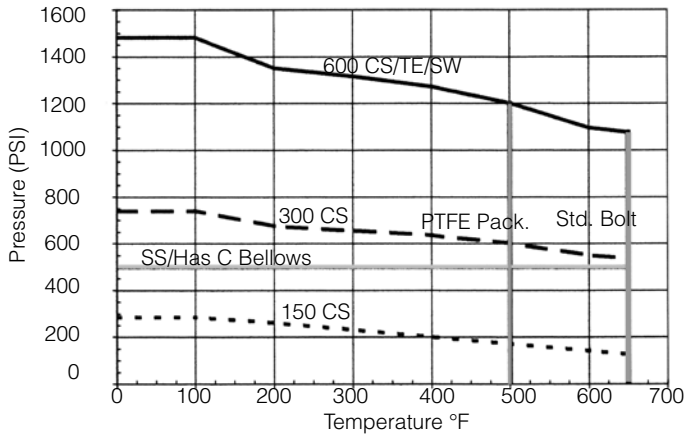

- Cast Iron

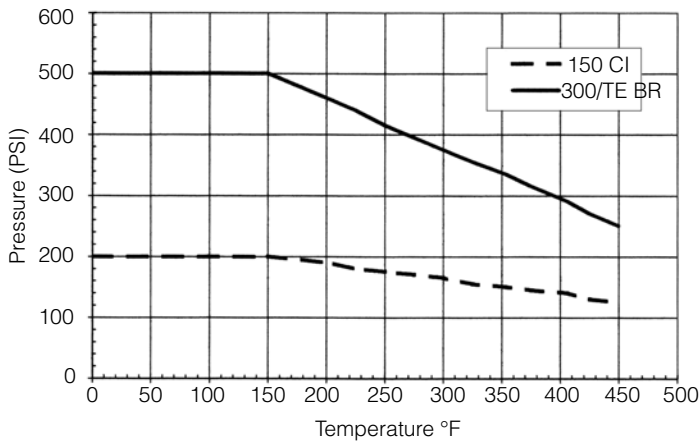

- Bronze

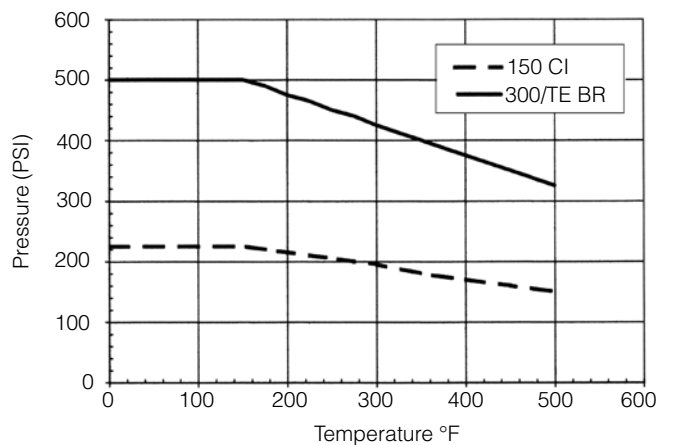

# MARK 70 SLIDING GATE CONTROL VALVES

## DIMENSIONS

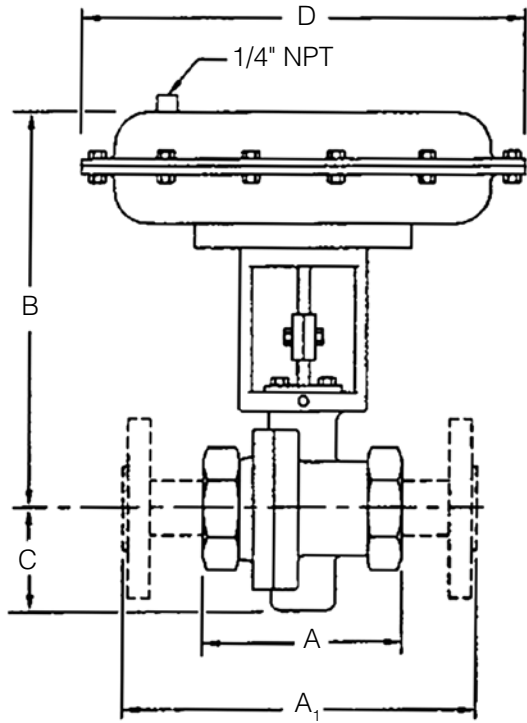

- Mark 70: Flanged Ends

Size	ANSI Flange	Dimensions (inches)				Weight (lbs)
		A <sub>1</sub>	B	C	D	
1/2"	150#	7.25	9.38	2.18	9.50	26
	300#	7.50	9.38	2.18	9.50	28
3/4"	150#	7.25	9.38	2.18	9.50	26
	300#	7.62	9.38	2.18	9.50	28
1"	150#	7.25	9.62	2.62	9.50	30
	300#	7.75	9.62	2.62	9.50	32
1-1/4"	150#	7.87	9.87	2.62	9.50	28
	300#	8.37	9.87	2.62	9.50	30
1-1/2"	150#	8.75	9.87	2.75	9.50	30
	300#	9.25	9.87	2.75	9.50	32
2"	150#	10.00	10.00	3.00	9.50	34
	300#	10.50	10.00	3.00	9.50	36

- Mark 70: Flanged Ends (metric)

Size	ANSI PN	Dimensions (mm)				Weight (kgs)
		A <sub>1</sub>	B	C	D	
DN15	10/16	130	238	55	241	11,8
	25/40	130	238	55	241	12,7
DN20	10/16	150	238	55	241	11,8
	25/40	150	238	55	241	12,7
DN25	10/16	160	244	67	241	12,7
	25/40	160	244	67	241	13,6
DN32	10/16	180	251	67	241	12,7
	25/40	180	251	67	241	13,6
DN40	10/16	200	251	70	241	13,6
	25/40	200	251	70	241	14,5
DN50	10/16	230	254	76	241	14,8
	25/40	230	254	76	241	16,3

- Mark 70: Threaded Ends

Size	Material	Dimensions (inches)				Weight (lbs)
		A	B	C	D	
1/2" & 3/4"	DI/BRZ	3.62	9.38	2.18	9.50	24
	CS/SS	3.65	9.38	2.18	9.50	24
1"	DI/BRZ	4.12	9.62	2.62	9.50	26
	CS/SS	4.12	9.62	2.62	9.50	28
1-1/4"	DI/BRZ	4.12	9.87	2.62	9.50	26
1-1/2"	DI/BRZ	4.50	9.87	2.62	9.50	27
	CS/SS	4.65	9.87	2.75	9.50	28
2"	DI/BRZ	4.50	10.00	2.62	9.50	29
	CS/SS	5.50	10.00	3.00	9.50	32

- Mark 70: Threaded Ends (metric)

Size	Material	Dimensions (mm)				Weight (kgs)
		A	B	C	D	
DN15 & 20"	DI/BRZ	92	238	55	241	10,9
	CS/SS	93	238	55	241	10,9
DN25	DI/BRZ	105	244	67	241	11,8
	CS/SS	105	244	67	241	12,7
DN32	DI/BRZ	105	251	67	241	11,8
DN40	DI/BRZ	114	251	67	241	12,2
	CS/SS	118	251	70	241	12,7
DN50	DI/BRZ	114	254	67	241	13,2
	CS/SS	140	254	76	241	14,5

# MARK 70 SLIDING GATE CONTROL VALVES

## DIMENSIONS

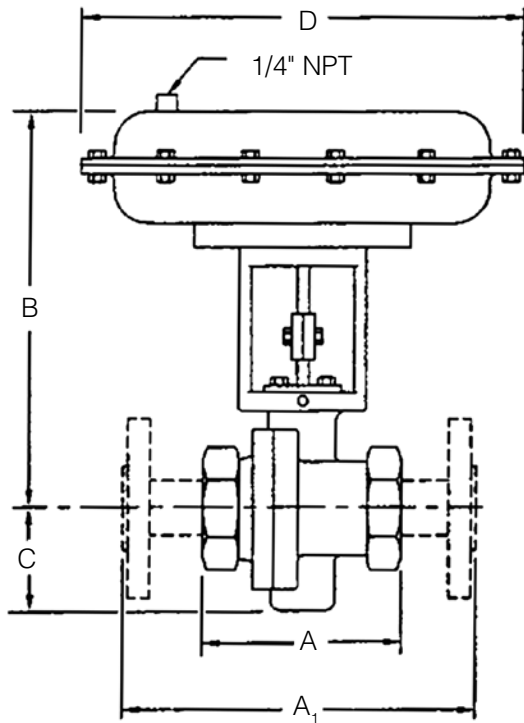

- Mark 707: Threaded Ends

Size	Material	Dimensions (inches)				Weight (lbs)
		A	B	C	D	
1/2"	DI/BRZ	3.62	9.38	2.18	9.50	24
	CS/SS	3.65	9.38	2.18	9.50	24
3/4"	DI/BRZ	4.12	10.82	2.62	12.50	37
	CS/SS	4.12	10.82	2.62	12.50	39
1"	DI/BRZ	4.12	10.82	2.62	12.50	37
	CS/SS	4.12	10.82	2.62	12.50	39
1-1/4"	DI/BRZ	4.12	11.07	2.62	12.50	37
1-1/2"	DI/BRZ	4.50	11.07	2.62	12.50	40
	CS/SS	4.65	11.20	3.00	12.50	43
2"	DI/BRZ	4.50	11.20	2.62	12.50	40
	CS/SS	5.50	11.20	3.00	12.50	43

- Mark 707: Threaded Ends (metric)

Size	Material	Dimensions (mm)				Weight (kgs)
		A	B	C	D	
DN15	DI/BRZ	92	238	55	241	11
	CS/SS	93	238	55	241	11
DN20	DI/BRZ	105	205	67	318	17
	CS/SS	105	275	67	318	18
DN25	DI/BRZ	105	205	67	318	17
	CS/SS	105	275	67	318	18
DN32	DI/BRZ	105	281	67	318	17
DN40	DI/BRZ	114	281	67	318	18
	CS/SS	140	284	76	318	20
DN50	DI/BRZ	114	284	67	318	18
	CS/SS	140	284	76	318	20

- Mark 707 & Mark 711: Flanged Ends

Size	ANSI Flange	Dimensions (inches)				Weight (lbs)
		A <sub>1</sub>	B	C	D	
2-1/2"	125/150#	10.87	19.50	5.12	15.00	210
	250/300#	11.50				
3"	125/150#	11.75	19.50	5.37	15.00	255
	250/300#	12.50				
4"	125/150#	13.87	20.75	6.00	15.00	325
	250/300#	14.50				
6"	125/150#	17.75	21.50	7.00	15.00	410
	250/300#	18.62				

- Mark 707 & Mark 711: Flanged Ends (metric)

Size	ANSI Flange	Dimensions (mm)				Weight (kgs) <sub>3</sub>
		A	B <sub>1</sub>	C	D <sub>2</sub>	
DN65	10/16	287	495	130	381	98
	25/40	293				
DN80	10/16	313	495	137	381	105
	25/40	313				
DN100	10/16	353	527	152	381	155
	25/40	353				
DN150	10/16	474	546	178	381	189
	25/40	474				

1 'B' dimensions are for 85M actuator, for 55M subtract 25,4 mm  
 2 'D' dimensions are for 85M actuator, for 55M subtract 63,6 mm  
 3 Weights are for 85M actuator, for 55M subtract 5 kgs

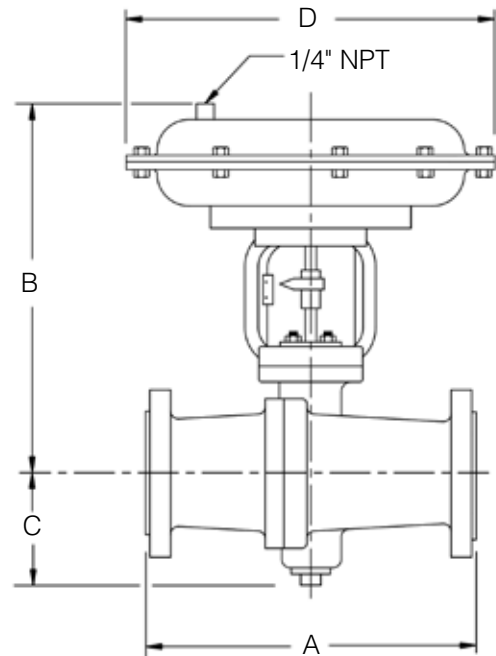

MARK 70 SLIDING GATE CONTROL VALVES

ORDERING SCHEMATIC

Model	Size	Body Mat'l	/	1	2	3	4	5	6	7	8	9	10	11	12	13	14	15	16	17

Model	
70	Standard
70SP	Standard with Side Positioner
70TP	Standard with Top Positioner
707	Equal Percentage
707SP	Equal Percentage with Side Positioner
707TP	Equal Percentage with Top Positioner
711	Linear
711SP	Linear with Side Positioner
711TP	Linear with Top Positioner

3 & 4 Trim	
T3	303SS/TFE Pkg
T6	316SS/TFE Pkg
I3	303SS/Graphite
I6	316SS/Graphite

Size			
050	1/2" (DN15)	200	2" (DN50)
075	3/4" (DN20)	250	2-1/2" (DN65)
100	1" (DN25)	300	3" (DN80)
125	1-1/4" (DN32)	400	4" (DN100)
150	1-1/2" (DN40)	600	6" (DN150)

5 Seat Material	
Q	303SST/Teflon Coated
R	316SST/Teflon Coated
V	303SS/Jorcote
W	316SS/Jorcote

Body Material	
DI	Ductile Iron
BR	Bronze
CS	Carbon Steel (WCB)
S6	Stainless Steel (CF8M)

6	Cv				
	MK70 & MK711			MK707	
1	0.21 (0,28)	A	25 (22)	5	2.5 (2,2)
2	0.42 (0,36)	B	30 (26)	6	4.4 (3,8)
3	0.84 (0,72)	C	50 (43)	N	11.5 (9,9)
4	1.6 (1,4)	F	85 (73)	P	13 (11,2)
5	2.5 (2,2)	G	115 (99)	S	22 (19)
6	4.4 (3,8)	H	130 (112)	U	34 (29)
7	6.4 (5,5)	I	200 (172)	1	60 (52)
8	9.5 (8,2)	J	395 (341)	2	80 (69)
9	15 (13,0)			H	130 (112)
				3	230 (199)

1 & 2 End Connections	
PT	NPT
BT	BSPT
I5	150# IFE DI above 2" or CS or SST valves
F5	150# FE DI below 2-1/2" or BR
I7	PN1" IFE DI above 2" or CS or SST valves
F7	PN1" FE DI below 2-1/2" or BR
I6	PN16 IFE DI above 2" or CS or SST valves
F6	PN16 FE DI below 2-1/2" or BR
BP	BSPP
SW	FSW
I3	300# IFE DI above 2" or CS or SST valves
F3	300# FE DI below 2-1/2" or BR
I8	PN25 IFE DI above 2" or CS or SST valves
F8	PN25 FE DI below 2-1/2" or BR
I4	PN40 IFE DI above 2" or CS or SST valves
F4	PN40 FE DI below 2-1/2" BR

7, 8, 9, 10, 11, 12	Mark 70 Series Range & Actuator	
	Range	Actuator
N3Q3N3	3-15 DIR	35M
Q3Q3N3	3-15 REV	

7, 8, 9, 10, 11, 12	All Mark 70 Models Range & Actuator	
	Range	Actuator
A3B3A3	3-15 DIR	35M
B3B3A3	3-15 REV	
G3B3A3	6-30 DIR	
H3B3A3	6-30 REV	
A5B5A5	3-15 DIR	55M
B5B5A5	3-15 REV	
G5B5A5	6-30 DIR	
H5B5A5	6-30 REV	
A8B8A8	3-15 DIR	85M
B8B8A8	3-15 REV	
G8B8A8	6-30 DIR	
H8B8A8	6-30 REV	



ORDERING SCHEMATIC, CONT.

Model	Size	Body Mat'l	/	1	2	3	4	5	6	7	8	9	10	11	12	13	14	15	16	17	

13 & 14	Accessories
00	None
AR	Air Regulator
H3	Handwheel 35M Actuator
H5	Handwheel 55M Actuator
H8	Handwheel 85M Actuator
S6	316SS Bolting

15	Action
D	Air-to-Close
R	Air-to-Open

16	I/P
0	None
3	I/P 35M Actuator
5	I/P 55M Actuator
8	I/P 85M Actuator

17	SMP
0	None
A	SMP DIR/REV 3-15
B	SMP DIR/REV 3-9
C	SMP DIR/REV 9-15
D	SMP/IP DIR/REV 4-20
E	SMP/IP DIR/REV 4-12
F	SMP/IP DIR/REV 12-20
G	MK16IQ-S DIR/REV 4-20 (Hart & FM-App)
H	MK16IQ-B DIR/REV 4-20 (with gauges)
J	MK16IQ-FF DIR/REV 4-20 (Fieldbus w/ gauges)
Z	Non-Standard

# Mark 701/702 Series

## High-Flow and Super High-Flow Control Valves

The Mark 701/702 high-flow and super high-flow sliding gate control valves provide:

- Shorter Stroke than a globe or plug-style valve
  - Faster response
  - Longer packing and seat life
  - Stem packing is four times deeper than stem travel – for greater protection against leakage
  - Smaller and lighter weight than globe-style valves
- Straight through flow
  - Less turbulence, erosion and noise
  - Fewer spare parts
  - Self-cleaning seats
  - No gaskets or o-rings
- Ease of maintenance
  - Interchangeable seats and Cv's
  - Fewer spare parts
  - Self-cleaning seats
  - No gaskets or o-rings



### SPECIFICATIONS

**Sizes:** 1/2" through 2" (DN15 through DN50)

#### End Connections

- Threaded (NPT, BSPT, BSPP)
- ANSI Flanges (150#, 300#)
- DIN Flanges (PN10/16; PN25/40)

#### Body Materials

- Ductile Iron
- Bronze
- Carbon Steel (WCB)
- Stainless Steel (CF8M)

#### Trim Materials

- 303SS for CI, DI, BRZ & CS body valves
- 316SS for SS body valves

#### Seat Materials

- Jorcote on SST – standard

**Yoke:** Cast Iron

**Actuator:** Steel

**Diaphragm:** Buna-N (standard, to 200°/93°C)

**Stem Packing:** Spring-loaded Teflon (to 450°F/232°C); Graphite (to 1200°/649°C)

**Service:** steam, water, oil, gas, air and chemicals

**Shutoff:** ANSI Class IV

**Ranges:** 3-15, 3-9, 9-15, 6-30 psi (0,21-1,03; 0,21-0,62; 0,62-1,03; 0,41-2,1 bar)

#### Action

- Direct (air signal closes valve)
- Reverse (air signal opens valve)

**Positioner:** Side or top mounted positioners are available to ensure that the valve stem position is always directly proportional to the control system output signal. See the Positioner section for more details.

#### Body Rating

- Ductile Iron up to 988 psi (68,1 bar) @ 100°F (38°C) and 715 psi (49,3 bar) @ 650°F (343°C)
- Carbon Steel and Stainless Steel up to 1440 psi (99 bar) @ 100°F (38°C) and 890 psi (61 bar) @ 650°F (343°C)
- Bronze up to 500 psi (35 bar) @ 100°F (38°C) and 325 psi (22 bar) @ 500°F (260°C)
- Temperature limit of -20°F (-29°C) on all materials; for other temperatures, consult factory

**DIMENSIONS**

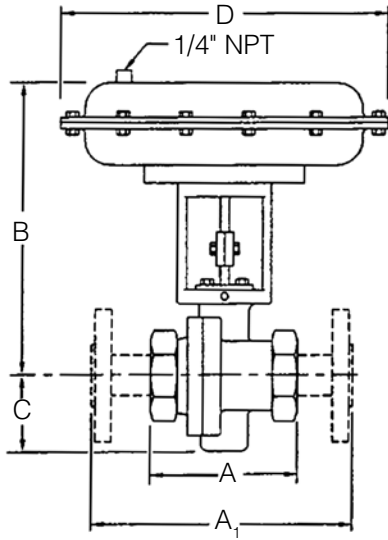

• Mark 701/702: Flanged Ends

Size	ANSI Flange	Dimensions (inches)				Weight (lbs)
		A <sub>1</sub>	B	C	D	
1/2"	150#	7.25	10.38	2.18	12.5	37
	300#	7.50	10.38	2.18	12.5	39
3/4"	150#	7.25	10.38	2.18	12.5	41
	300#	7.62	10.38	2.18	12.5	45
1"	150#	7.25	10.62	2.62	12.5	41
	300#	7.75	10.62	2.62	12.5	45
1-1/4"	150#	7.87	10.87	2.62	12.5	41
	300#	8.37	10.87	2.62	12.5	45
1-1/2"	150#	8.75	10.87	2.75	12.5	46
	300#	9.25	10.87	2.75	12.5	55
2"	150#	10.00	11.00	3.00	12.5	50
	300#	10.50	11.00	3.00	12.5	57

• Mark 701/702: Flanged Ends (metric)

Size	ANSI PN	Dimensions (mm)				Weight (kgs)
		A <sub>1</sub>	B	C	D	
DN15	10/16	130	263	55	318	16,8
	25/40	130	263	55	318	17,7
DN20	10/16	150	263	55	318	18,6
	25/40	150	263	55	318	20,4
DN25	10/16	160	270	67	318	18,6
	25/40	160	270	67	318	20,4
DN32	10/16	180	276	67	318	18,6
	25/40	180	276	67	318	20,4
DN40	10/16	200	276	70	318	20,9
	25/40	200	276	70	318	24,9
DN50	10/16	230	284	76	318	22,7
	25/40	230	284	76	318	25,9

**Cv VALUES AND MAXIMUM ALLOWABLE DIFFERENTIAL PRESSURE RATINGS**

Cv	Valve Size	Seat Material	Max ΔP, PSI * (BAR)	
			55M Actuator	35M w/Positioner
6.4 (5,5)	1/2" & 3/4" (DN15 & 20)	SST	125 (8,6)	150 (10,3)
		Jorcote	200 (13,8)	250 (17,2)
7.0 (6,0)	1/2" (DN15)	SST	125 (8,6)	150 (10,3)
		Jorcote	200 (13,8)	250 (17,2)
9.5 (8,2)	3/4" (DN20)	SST	125 (8,6)	150 (10,3)
		Jorcote	200 (13,8)	250 (17,2)
15 (12,9)	1" & 1-1/4" (DN25 & 32)	SST	100 (6,9)	100 (6,9)
		Jorcote	150 (10,3)	200 (13,8)
18 (15,5)	1" (DN25)	SST	100 (6,9)	100 (6,9)
		Jorcote	150 (10,3)	200 (13,8)
25 (22)	1-1/4" DN32)	SST	100 (6,9)	100 (6,9)
		Jorcote	150 (10,3)	200 (13,8)
30 (26)	1-1/2" & 2" (DN40 & 50)	SST	100 (6,9)	100 (6,9)
		Jorcote	150 (10,3)	200 (13,8)
35 (30)	1-1/2" & 2" (DN40 & 50)	SST	100 (6,9)	100 (6,9)
		Jorcote	150 (10,3)	200 (13,8)
45 (39)	1-1/2" (DN40)	SST	100 (6,9)	100 (6,9)
		Jorcote	150 (10,3)	200 (13,8)
50 (43)	2" (DN50)	SST	100 (6,9)	100 (6,9)
		Jorcote	150 (10,3)	200 (13,8)
65 (56)	1-1/2" (DN40)	SST	100 (6,9)	125 (8,6)
		Jorcote	150 (10,3)	150 (10,3)
70 (61)	2" DN50)	SST	100 (6,9)	125 (8,6)
		Jorcote	150 (10,3)	150 (10,3)

• Mark 701/702: Threaded Ends

Size	Material	Dimensions (inches)				Weight (lbs)
		A	B	C	D	
1/2"	DI/BRZ	3.62	10.38	2.18	12.50	35
	CS/SS	3.65	10.38	2.18	12.50	35
3/4"	DI/BRZ	3.62	10.38	2.18	12.50	35
	CS/SS	3.65	10.38	2.18	12.50	35
1"	DI/BRZ	4.12	10.62	2.62	12.50	37
	CS/SS	4.12	10.62	2.62	12.50	39
1-1/2"	DI/BRZ	4.50	10.87	2.62	12.50	40
	CS/SS	5.00	10.87	3.00	12.50	43
2"	DI/BRZ	4.50	11.00	2.62	12.50	40
	CS/SS	5.50	11.00	3.00	12.50	43

• Mark 701/702: Threaded Ends (metric)

Size	Material	Dimensions (mm)				Weight (kgs)
		A	B	C	D	
DN15	DI/BRZ	92	264	55	318	16
	CS/SS	93	264	55	318	16
DN20	DI/BRZ	92	264	55	318	16
	CS/SS	93	264	55	318	16
DN25	DI/BRZ	105	270	67	318	17
	CS/SS	105	270	67	318	18
DN40	DI/BRZ	114	284	67	318	18
	CS/SS	140	284	76	318	20
DN50	DI/BRZ	114	284	67	318	18
	CS/SS	140	284	76	318	20

PRESSURE-TEMPERATURE CHARTS – MK701/702

- Ductile Iron

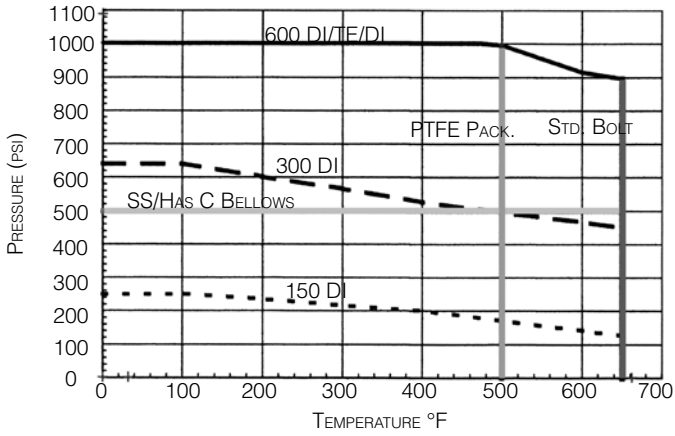

- Stainless Steel

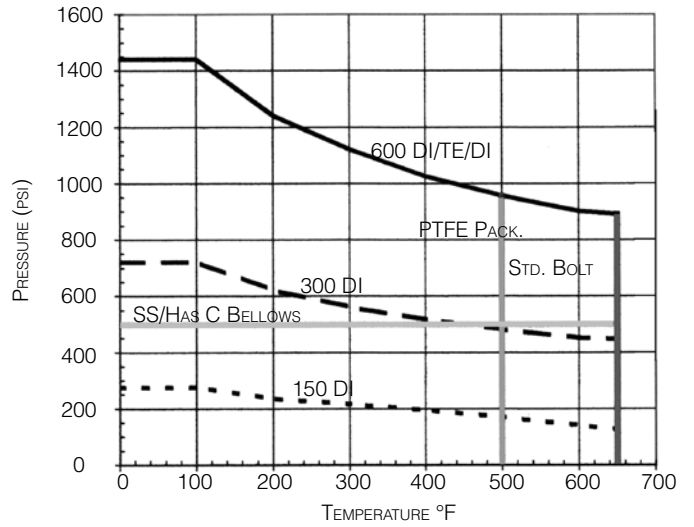

- Carbon Steel

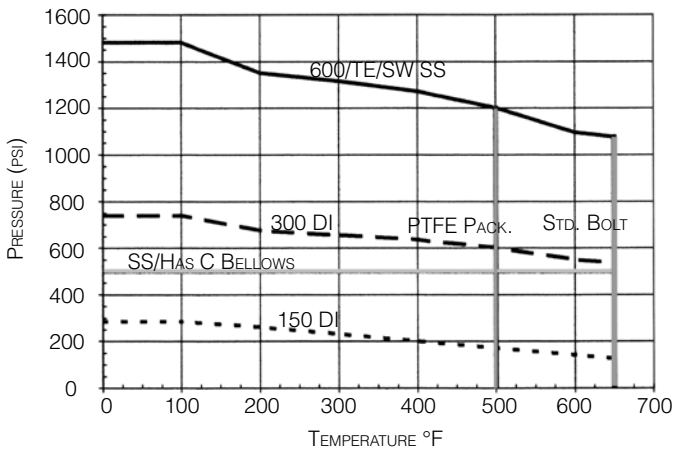

- Bronze

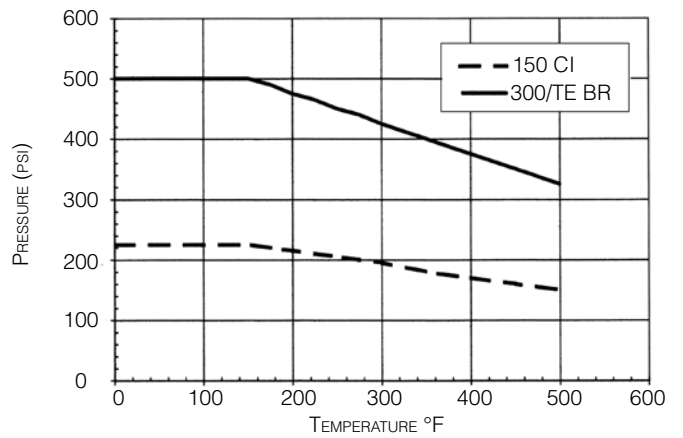

MARK 701/702 HIGH FLOW & SUPER HIGH FLOW SLIDING GATE CONTROL VALVES

ORDERING SCHEMATIC

Model	Size	Body Mat'l	/	1	2	3	4	5	6	7	8	9	10	11	12	13	14	15	16	17

	Model
701	High Flow
701SP	High Flow with Side Positioner
701TP	High Flow with Top Positioner
702	Super High Flow
702SP	Super High Flow with Side Positioner
702TP	Super High Flow with Top Positioner

3 & 4	Trim
T3	303SS/TFE Pkg
T6	316SS/TFE Pkg

	Size
050	1/2" (DN15)
075	3/4" (DN20)
100	1" (DN25)
125	1-1/4" (DN32)
150	1-1/2" (DN40)
200	2" (DN50)

5	Seat Material
A	303SST
B	316SST
Q	303SST/Teflon Coated
R	316SST/Teflon Coated
V	303SS/Jorcote
W	316SS/Jorcote

	Body Material
DI	Ductile Iron
BR	Bronze
CS	Carbon Steel (WCB)
S6	Stainless Steel (CF8M)

6	Cv		
7	6.4 (5,5)	A	25 (22)
L	6.4 (5,5)	B	30 (26)
M	9.0 (7,8)	V	35 (31)
8	9.5 (8,2)	W	45 (39)
9	15 (13)	C	50 (43)
R	18 (15,5)	Y	65 (56)
T	24 (21)	E	70 (60)

1 & 2	End Connections
PT	NPT
BT	BSPT
I5	150# IFE DI above 2" or CS or SST valves
F5	150# FE DI below 2-1/2" or BR
I7	PN10 IFE DI above 2" or CS or SST valves
F7	PN10 FE DI below 2-1/2" or BR
I6	PN16 IFE DI above 2" or CS or SST valves
F6	PN16 FE DI below 2-1/2" or BR
BP	BSPP
SW	FSW
I3	300# IFE DI above 2" or CS or SST valves
F3	300# FE DI below 2-1/2" or BR
I8	PN25 IFE DI above 2" or CS or SST valves
F8	PN25 FE DI below 2-1/2" or SST valves
I4	PN40 IFE DI above 2" or CS or SST valves
F4	PN40 FE DI below 2-1/2" or BR

7, 8, 9, 10, 11, 12	Range & Actuator	
	Range	Actuator
A3B3A3	3-15 DIR	35M
B3B3A3	3-15 REV	
G3B3A3	6-30 DIR	
H3B3A3	6-30 REV	55M
A5B5A5	3-15 DIR	
B5B5A5	3-15 REV	
G5B5A5	6-30 DIR	85M
H5B5A5	6-30 REV	
A8B8A8	3-15 DIR	
B8B8A8	3-15 REV	85M
G8B8A8	6-30 DIR	
H8B8A8	6-30 REV	

**ORDERING SCHEMATIC, CONT.**

<b>13 &amp; 14</b>	<b>Accessories</b>
00	None
AR	Air Regulator
H3	Handwheel 35M Actuator
H5	Handwheel 55M Actuator
H8	Handwheel 85M Actuator
S6	316SS Bolting

<b>15</b>	<b>Action</b>
D	Air-to-Close
R	Air-to-Open

<b>16</b>	<b>I/P</b>
0	None
3	I/P 35M Actuator
5	I/P 55M Actuator
8	I/P 85M Actuator

<b>17</b>	<b>SMP</b>
0	None
A	SMP DIR/REV 3-15
B	SMP DIR/REV 3-9
C	SMP DIR/REV 9-15
D	SMP/IP DIR/REV 4-20
E	SMP/IP DIR/REV 4-12
F	SMP/IP DIR/REV 12-20
G	MK16IQ-S DIR/REV 4-20 (Hart & FM-App)
H	MK16IQ-B DIR/REV 4-20 (with gauges)
J	MK16IQ-FF DIR/REV 4-20 (Fieldbus w/ gauges)
Z	Non-Standard



**Jordan Valve, a division of Richards Industries**  
 3170 Wasson Road • Cincinnati, OH 45209  
 513.533.5600 • 800.543.7311 • 513.871.0105 (f)  
 info@richardsind.com • www.jordanvalve.com