

Mark 68G Series

CRN Registration Number Available

Pressure Regulators

The Mark 68G is a globe-style pressure reducing regulating valve that offers high capacity, accurate regulation, and easy servicing, making it the ideal choice for your industrial-grade pressure reducing applications. The bottom-entry design ensures the Mark 68G is easy to clean or repair. The diaphragm can be easily accessed from the top allowing some repairs to be conducted without removing the valve from the line.

OPERATION

The downward force of the spring holds the plug normally open. As downstream pressure increases, due to a decrease in flow demand, it forces the diaphragm up, closing the valve. As the valve closes the inlet pressure is then reduced to the selected setpoint. The controlled downstream pressure is set with the adjusting screw. A selection of spring ranges are available for a wide range of settings.

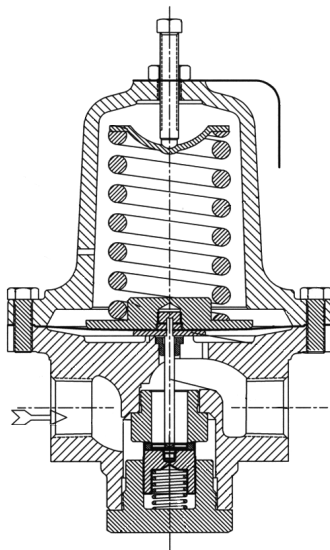

FEATURES

- Easy to maintain and service – bottom entry to expose plug, stem and seat; diaphragm accessible from top, allows for in-line maintenance
- Large effective diaphragm area – reduces droop for increased accuracy and sensitivity
- large orifices and body passages – provides high flow capacities
- Tight shutoff – your choice of hard (ANSI Class IV) or soft (ANSI Class VI bubble-tight) shutoff
- For applications with differential pressures up to 300 psi (21 bar) – on water, air, oil, gas, steam and chemicals
- Easily replaceable soft seals



Jordan Valve a division of Richards Industries
3170 Wasson Road • Cincinnati, OH 45209
513.533.5600 • 800.543.7311 • 513.871.0105 (f)
info@richardsind.com • www.jordanvalve.com

SPECIFICATIONS

Sizes: 1/2" through 2" (DN8 through DN50)

End Connections

- Threaded – NPT, BSPT, BSPP
- Flanged

Body Materials*

- Bronze
- Ductile Iron
- Carbon Steel
- Stainless Steel

Plug Materials

- Buna-N
- Viton
- Hardened 17-4 pH Stainless Steel
- EPDM

Trim and Seat Material: 316 Stainless Steel

Spring Housing Material*: Cast Iron
Optional: Carbon Steel, Stainless Steel

Diaphragm Material*

- Buna-N/Nylon (200°F (93°C) temp limit)
- Stainless Steel (500°F (260°C) temp limit)
- Viton/Nomex (450°F (232°C) temp limit)
- Jorlon (450°F (232°C) temp limit)

Shutoff

- Hard Seat – ANSI Class IV
- Soft Seat – ANSI Class VI (for bubble-tight shutoff)

Spring Ranges: PSI (BAR)

Range		
Size	PSI	Bar
1/4", 3/8", 1/2" (DN8, DN10, DN15)	2-7, 5-15, 10-55 50-160, 150-200	0,14-0,48; 34-1,0; 0,7-3,8; 3,4-11,0; 10,3-13,8
3/4" & 1" (DN20 & DN25)	3-10, 5-20, 15-45 35-70, 60-105 95-140, 130-180	0,21-0,7; 0,34-1,4; 1,0-3,1; 2,4-4,8; 4,1-7,2; 6,6-9,7; 9,0-1,24
1-1/4", 1-1/2", 2" (DN32, DN40, DN50)	2-16, 10-25, 20-65 55-100, 90-160	0,14-1,1; 0,7-1,7; 1,4-4,5; 3-8-6,9; 6,2-11,0

* For other materials, please consult factory

Maximum Inlet Pressure: 300 psi (20,7 bar)

Maximum Temperature

- 200°F (93°C) with Buna-N plug and diaphragm
- 350°F (177°C) with Viton plug and Viton or SST diaphragm
- 500°F (260°C) with metal seat and SST diaphragm

Minimum Temperature

- -20°F (-29°C) with Buna-N plug and diaphragm
- -15°F (-26°C) with SST diaphragm and SST or Viton plug
- -20°F (-29°C) with SST diaphragm and Buna-N plug

Cv (Kv Values)

Valve Size	Valve Cv (Kv)	
1/4" (DN8)	Standard	2.2 (1,9)
1/4" (DN8)	Optional	0.21 (0,18); 0.42 (0,36); 0.84 (0,72); 1.6 (1,4)
3/8" (DN10)	Standard	2.6 (2,24)
3/8" (DN10)	Optional	0.21 (0,18); 0.42 (0,36); 0.84 (0,72); 1.6 (1,4)
1/2" (DN15)	Standard	2.9 (2,5)
1/2" (DN15)	Optional	0.21 (0,18); 0.42 (0,36); 0.84 (0,72); 1.6 (1,4)
3/4" (DN20)	Standard	7.0 (6,0)
3/4" (DN20)	Optional	0.21 (0,18); 0.42 (0,36); 0.84 (0,72); 1.6 (1,4); 2.9 (2,5); 4.4 (3,8); 5.2 (4,5)
1" (DN25)	Standard	7.7 (6,6)
1" (DN25)	Optional	0.21 (0,18); 0.42 (0,36); 0.84 (0,72); 1.6 (1,4); 2.9 (2,5); 4.4 (3,8); 5.6 (4,8)
1-1/4" (DN32)	Standard	15.5 (13,3)
1-1/4" (DN32)	Optional	13.5 (11,6)
1-1/2" (DN40)	Standard	16.5 (14,2)
1-1/2" (DN40)	Optional	13.5 (11,6)
2" (DN50)	Standard	19.0 (16,3)
2" (DN50)	Optional	17.0 (14,6)
2" (DN50)	Optional	13.5 (11,6)

DIMENSIONS

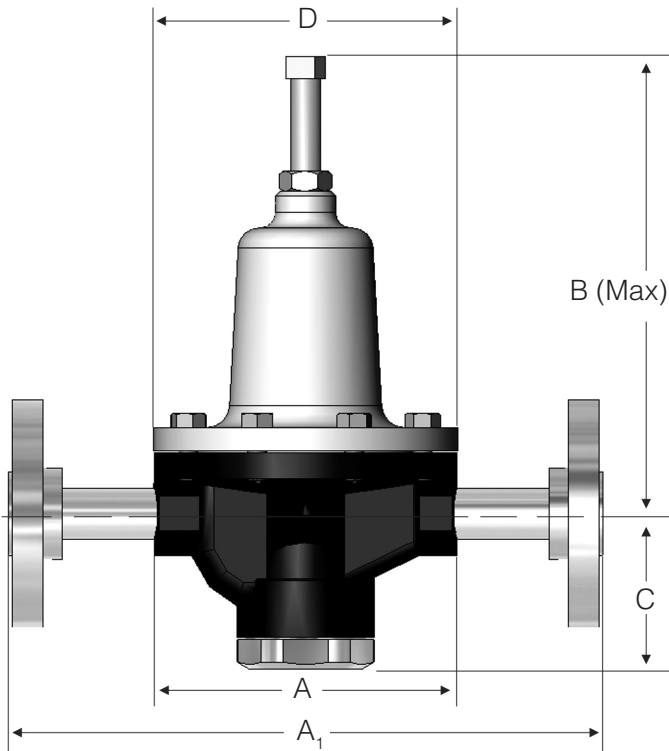

Flanged Ends

Valve Size	ANSI Flange	Dimensions (inches)				Weight lbs
		A1*	B	C	D	
1/2"	150#	9.50	7.56	2.56	5.00	13
	300#	9.75	7.56	2.56	5.00	16
3/4"	150#	9.50	9.37	2.62	6.87	24
	300#	9.75	9.37	2.62	6.87	27
1"	150#	9.50	9.37	2.62	6.87	24
	300#	9.75	9.37	2.62	6.87	27
1-1/4"	150#	13.00	16.75	3.87	9.37	74
	300#	13.25	16.75	3.87	9.37	77
1-1/2"	150#	13.00	16.75	3.87	9.37	74
	300#	13.25	16.75	3.87	9.37	81
2"	150#	13.00	16.75	3.87	9.37	78
	300#	13.25	16.75	3.87	9.37	83

* Not to ANSI

Flanged Ends, Metric

Valve Size	Flange	Dimensions (mm)				Weight kgs
		A1*	B	C	D	
DN15	10/16	241	192	65	127	5,9
	25/40	248	192	65	127	7,3
DN20	10/16	241	238	66,6	174	10,9
	25/40	248	238	66,5	174	12,2
DN25	10/16	241	238	66,5	174	10,9
	25/40	248	238	66,5	174	12,2
DN32	10/16	330	425,5	98	238	33,6
	25/40	337	425,5	98	238	34,9
DN40	10/16	330	425,5	98	238	33,6
	25/40	337	425,5	98	238	35,4
DN50	10/16	330	425,5	98	238	35,4
	25/40	337	425,5	98	238	37,6

* Not to DIN

Threaded Ends

Valve Size	Dimensions (inches)				Weight lbs
	A	B	C	D	
1/4"	5.00	7.56	2.56	5.00	11
3/8"	5.00	7.56	2.56	5.00	11
1/2"	5.00	7.56	2.56	5.00	11
3/4"	5.00	9.37	2.62	6.87	20
1"	5.00	9.37	2.62	6.87	20
1-1/4"	7.50	16.75	3.87	9.37	68
1-1/2"	7.50	16.75	3.87	9.37	68
2"	7.50	16.75	3.87	9.37	68

Threaded Ends, Metric

Valve Size	Dimensions (mm)				Weight kgs
	A	B	C	D	
DN8	127	192	65	127	5,0
DN10	127	192	65	127	5,0
DN15	127	192	65	127	5,0
DN20	127	238	66,5	174	9,0
DN25	127	238	66,5	174	9,0
DN32	191	426	98	238	31
DN40	191	426	98	238	31
DN50	191	426	98	238	31

ORDERING SCHEMATIC

Model No	Size	Body Mat'l	1	2	3	4	5	6	7	8	9	10	11	12	13	14

Model	
68G	Standard

Size	
025	1/4" (DN8)
038	3/8" (DN12)
050	1/2" (DN15)
075	3/4" (DN20)
100	1" (DN25)
125	1-1/4" (DN32)
150	1-1/2" (DN40)
200	2" (DN50)

Body Material*	
DI	Ductile Iron
CS	Carbon Steel (WCB)
S6	Stainless Steel (CF8M)
BR	Bronze

1 & 2	End Connections
PT	NPT
BT	BSPT
BP	BSPP
SW	FSW
F5	150# FE
F3	300# FE
ZZ	Non-Standard

3 & 4	Plug		Cv (Kv)
B	Buna-N	1	0.21 (0,18)
V	Viton	2	0.42 (0,36)
J	EPDM	3	0,84 (0,72)
M	Hard	4	1.6 (1,4)
		5	2.2 (1,9)
		6	2.6 (2,2)
		7	2.9 (2,5)
		8	4.4 (3,8)
		9	5.2 (4,5)
		B	5.6 (4,8)
		F	7.0 (6,0)
		G	7.7 (6,6)
		M	13.5 (11,6)
		P	15.5 (13,4)
		Q	16.5 (14,2)
		S	17.0 (14,7)
		W	19.0 (16,4)
ZZ			Non-Standard

5 & 6	Range PSI (BAR)	
	1/4", 3/8", 1/2"	
C4	2 - 7	(0,14 - 0,48)
27	5 - 15	(0,34 - 1,03)
CA	10 - 55	(0,7 - 3,8)
CL	50 - 160	(3,5 - 11,0)
CV	150 - 200	(10,3 - 13,8)
	3/4", 1"	
C6	3 - 10	(0,21 - 0,7)
28	5 - 20	(0,34 - 1,4)
CB	15 - 45	(1,0 - 3,1)
CF	35 - 70	(2,4 - 4,8)
CN	60 - 105	(4,1 - 7,2)
CQ	95 - 140	(6,6 - 9,7)
CT	130 - 180	(9,0 - 12,4)
	1-1/4", 1-1/2", 2"	
12	2 - 16	(0,14 - 1,10)
32	10 - 25	(0,7 - 1,7)
60	20 - 65	(1,4 - 4,5)
CM	55 - 100	(3,8 - 6,9)
CP	90 - 160	(6,2 - 11,0)
ZZ	Non-Standard	

7 & 8	Diaphragm*
BN	Buna-N
JL	Jorlon
S6	316SST
VI	Viton
ZZ	Non-Standard

9 & 10	Actuator
MD	For Metal Diaphragm
ED	For Elastomer Diaphragm
SM	316 Housing with Metal Diaphragm
SE	316 Housing with Elastomer Diaphragm
CM	CS Housing with Metal Diaphragm
CE	CS Housing with Elastomer Diaphragm
ZZ	Non-Standard

11 & 12	Accessories
00	None
SC	Oil Free Clean
XC	Oxygen Clean

13 & 14	PED Compliance
00	Not Required
FF	CE Category 1
ZZ	Non-Standard

* For other materials, please consult factory

