

Flowmeter

6001 / 6002

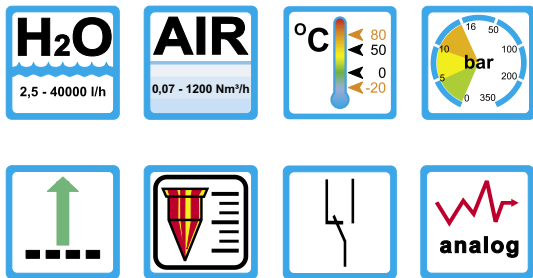

Range of applications

Operation

- Float measuring principle

Application

- Water treatment
- Chemical industry
- Laboratories
- Air-conditioning
- Cooling systems

Features

- Easy installation
- Low pressure drop
- Good chemical resistance
- Direct readable scale
- Threaded connection (6001) or flange-connection (6002)
- Options: adjustable limit switches, analog transmitter

Installation hints

- The operating instruction for type series 6000 must be observed!
- Download: www.meister-flow.com

Operating Data

Type	6001 6002	6001-SS 6002-SS	6001-PVC 6002-PVC	6001-PTFE 6002-PTFE
Operating temperature	-20 °C to +80 °C	-20 °C to +80 °C	0 °C to +50 °C	-20 °C to +80 °C
Operating pressure	PN 5 to PN 15 depending on type (see table on page 3)			
Pressure drop	see table on page 3			
Accuracy	classified 1,6 (VDI / VDE 3513)			
Connection	thread (6001), flange (6002)			

Measuring Ranges

Type	Flow ranges (water at 20 °C)		
	[l/h]	[l/h]	
C311-0025	2,5 - 25	C315-4000	400 - 4000
C311-0040	4 - 40	C315-6300	500 - 6300
C311-0060	6 - 60		
		C316-M010	1000 - 10000
C312-0100	10 - 100	C316-M014	2000 - 14000
C312-0160	16 - 160		
C312-0250	25 - 250	C317-M016	1600 - 16000
		C317-M020	2000 - 20000
C313-04001	40 - 400	C317-M030	3000 - 30000
C313-06301	60 - 630	C317-M040	6000 - 40000
C313-10001	100 - 1000		
		C30-00251	2,5 - 25
C314-1600	160 - 1600	C30-00401	4 - 40
C314-2500	250 - 2500		



Dimensions, technical data, materials

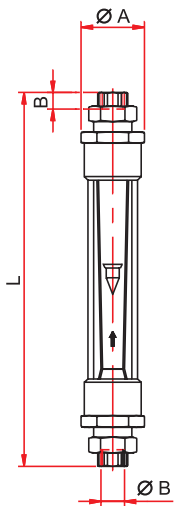

6001

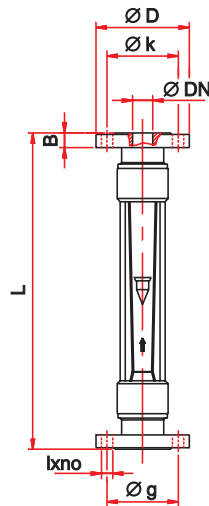
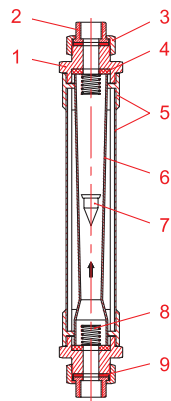

6002

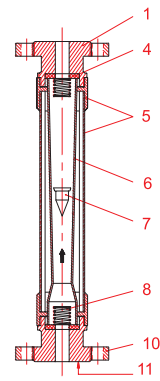

Dimensions and weights of Type 6001

R	DN	A	B	L	weight [kg]
1/2"	15	60	15	410	1,8
3/4"	20	60	15	415	2,2
1"	25	75	20	425	3,3
1 1/2"	40	105	20	445	5,9
2"	50	120	25	460	9,6
2 1/2"	65	150	25	505	12,5
3"	80	150	30	510	16,5

Dimensions and weights of Type 6002 (DIN 2501)

DN	D	k	g	B	lxno	L	weight [kg]
15	95	65	45	14	14x4	380	2,5
20	105	75	58	14	14x4	380	3,3
25	115	85	68	16	14x4	390	4,8
40	150	110	88	16	18x4	400	8
50	165	125	102	18	18x4	410	11
65	185	145	122	18	18x4	420	15,3
80	200	160	138	20	18x4	420	19,3

Materials

No.	Description	6001 6002	6001-SS 6002-SS
1	End pieces	Steel	SS 1.4404
2	Connection	Steel	SS 1.4404
3	Nut	Steel	Steel
4	Gaskets	NBR **	NBR**
5	Body	Steel, coated	Steel, coated *
6	Measuring tube	Borosilicate glass	Borosilicate glass
7	Float	1.4404, glass, alu.	1.4404, glass, alu.
8	Spring	1.4401	1.4404
9	Gaskets	NBR **	NBR **
10	Flange	Steel	Steel / 1.4404
11	Flange face	Steel	1.4404

* Stainless steel 1.4404 on request

** Other gasket materials on request

Materials

No.	Description	6001-PVC 6002-PVC	6001-PTFE 6002-PTFE
1	End pieces	PVC	Steel-PTFE / PTFE
2	Connection	PVC	PTFE
3	Nut	PVC	PTFE
4	Gaskets	NBR **	NBR **
5	Body	Steel, coated *	Steel, coated *
6	Measuring tube	Borosilicate glass	Borosilicate glass
7	Float	PVC	PTFE / PVDF
8	Spring	PVC	PTFE / PVDF
9	Gaskets	NBR **	NBR **
10	Flange	Steel / PVC	Steel / PTFE
11	Flange face	PVC	PTFE

* Stainless steel 1.4404 on request

** Other gasket materials on request

6000 2 0004 05-09 E M



Measuring ranges

Float type

AC 

Tube Type C Model-No.	Stainless Steel 1.4404 7,95 g/cm ³				Aluminium 2,85 g/cm ³		Pressure [bar]
	Water 20 °C [l/h]		Air *1 [Nm ³ /h]		Air *1 [Nm ³ /h]		
	min	max	min	max	min	max	
C311-0025	2,5	25	0,07	0,7	0,04	0,4	15
C311-0040	4	40	0,11	1,1	0,07	0,7	15
C311-0060	6	60	0,18	1,8	0,10	1	15
C312-0100	10	100	0,30	3	0,17	1,7	15
C312-0160	16	160	0,45	4,5	0,25	2,5	15
C312-0250	25	250	0,7	7	0,4	4	15
C313-04001	40	400	1,1	11	0,7	7	15
C313-06301	60	630	1,8	18	1	10	15
C313-10001	100	1000	3	30	1,7	17	15
C314-1600	160	1600	4,5	45	2,5	25	10
C314-2500	250	2500	7	70	4	40	10
C35-40001	400	4000	11	110	7	70	8
C35-63001	500	6300	18	180	10	100	8

Model

6001 and 6002

Tube Type C Model-No.	1.4404	Alum.	Tube length (± 1mm) [mm]	R	DN
	Pressure drop for Water				
	[mm H ₂ O]	[mm H ₂ O]			
C311-0025	55	22	300	1/2" / 3/4"	15 / 20
C311-0040	55	22	300	1/2" / 3/4"	15 / 20
C311-0060	55	22	300	1/2" / 3/4"	15 / 20
C312-0100	90	35	300	1/2" / 3/4"	15 / 20
C312-0160	90	35	300	1/2" / 3/4"	15 / 20
C312-0250	90	35	300	1/2" / 3/4"	15 / 20
C313-04001	125	50	300	3/4" / 1"	20 / 25
C313-06301	125	50	300	3/4" / 1"	20 / 25
C313-10001	125	50	300	3/4" / 1"	20 / 25
C314-1600	175	75	300	1 1/2"	40
C314-2500	175	75	300	1 1/2"	40
C315-4000	230	95	300	1 1/2"	40
C315-6300	230	95	300	1 1/2"	40

Float type

AC 

Tube Type C Model-No.	Stainless Steel 1.4404 7,95 g/cm ³				Aluminium 2,85 g/cm ³		Pressure [bar] max
	Water 20 °C [l/h]		Air *1 [Nm ³ /h]		Air *1 [Nm ³ /h]		
	min	max	min	max	min	max	
C316-M010	1000	10000	30	300	17	170	6
C316-M014	2000	14000	120	420	45	200	6
C317-M016	1600	16000	45	450	25	250	5
C317-M020	2000	20000	60	600	35	350	5
C317-M030	3000	30000	90	900	50	500	5
C317-M040	6000	40000	180	1200	100	712	5

Model

6001 and 6002

Tube Type C Model-No.	1.4404	Alum.	Tube length (± 1mm) [mm]	R	DN
	Pressure drop for Water				
	[mm H ₂ O]	[mm H ₂ O]			
C316-M010	300	125	300	2"	50
C316-M014	300	125	300	2"	50
C317-M016	400	170	300	2 1/2" / 3"	65 / 80
C317-M020	400	170	300	2 1/2" / 3"	65 / 80
C317-M030	400	170	300	2 1/2" / 3"	65 / 80
C317-M040	400	170	300	2 1/2" / 3"	65 / 80

*1 at 1,013 bar abs. and 20 °C

*1 at 1,013 bar abs. and 20 °C

Float type

AC 

ECG 

Tube Type C Model-No.	Stainless Steel 1.4404 7,95 g/cm ³				Glass 2,6 g/cm ³			
	Water 20 °C [l/h]		Air *1 [Nm ³ /h]		Water 20 °C [l/h]		Air *1 [Nm ³ /h]	
	min	max	min	max	min	max	min	max
C30-00251	2,5	25	70	700	1	10	40	400
C30-00401	4	40	120	1200	1,6	16	70	700

Model

6001 and 6002

Tube Type C Model-No.	Pressure [bar] max	1.4404	Glas	Tube length (± 1mm) [mm]	R	DN
		Pressure drop for water				
		[mm H ₂ O]	[mm H ₂ O]			
C30-00251	15	30	15	300	1/2"	15
C30-00401	15	30	15	300	1/2"	15

*1 at 1,013 bar abs. and 20 °C

6000 3 0005 05-09 E M



Options

60-AMM ... 60-AMD

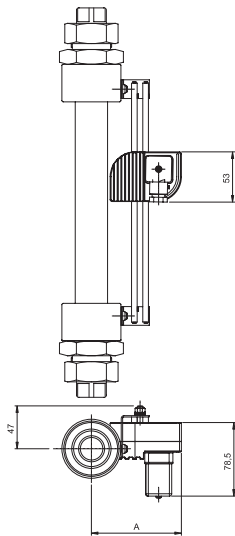

60-AMR ... 60-AMO

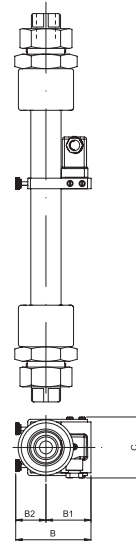

Dimensions 60-AMM ... 60-AMD

DN	A
15 – 20	90
20 – 25	96
40	111
50	117
65 – 80	130

Dimensions 60-AMR ... 60-AMO

DN	B1	B2	B	C
15 – 20	50	31	81	56
20 – 25	52	35	87	70
40	60	41	101	96
50	71	45	116	112
65 – 80	84	52	136	135

Microswitch 60-AMM

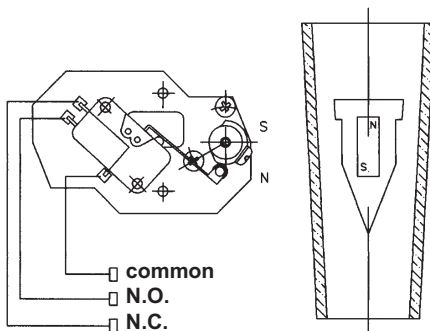

For measuring ranges from 40 to 400 l/h water and 0,7 to 7 Nm³/h air

The magnet in the float operates the micro switch (change over contact) mounted in an aluminium case.

- 1 or 2 adjustable limit switches
- Switch values: 3 (1) A, 250 V ~ (VDE/CEE)
- Hysteresis: ± 10 % from full scale
- Ambient temperature: -25 °C to +80 °C
- Mechanical lifetime: 10⁷ switch operations

(gold-plated contacts on request)



Options

Inductive contact 60-AMD*

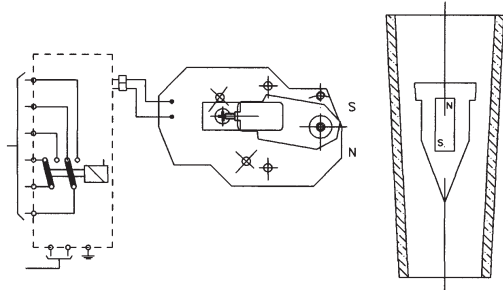

For measuring ranges from 40 - 400 l/h water and 0,7 - 7 Nm³/h air

The magnet in the float operates the inductive contact in an aluminium box.

(Type SJ 3,5 N NAMUR / DIN 19234)

- 1 or 2 adjustable limit switches
- Power supply: 8 V DC (switch amplifier)
- Ambient temperature: -25 °C to +70 °C

switch amplifier (on request)

Model NAMUR (DIN 19234), for 1 or 2 inductive contacts

- Power supply: 24...230 V AC, 50 - 60 Hz
24...250 V DC
- Input: intrinsically safe circuit EEx ia IIC
- Output: 1 or. 2 relays
- Load: 2...5 A / 40 V DC
- Ambient temperature: -25 °C to +70 °C

* requires amplifier relay

Optical alarm 60-AMO**

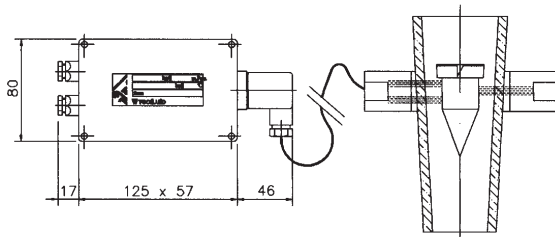

For measuring ranges from 6 - 60 l/h water and 0,1 - 1 Nm³/h air

The optical contact (infrared light) will be activated by interruption of the light beam through the float.

The sensor is mounted in a PVC support.

The relay is in a separate aluminum box (IP 65).

The cable length between the control relay and the sensor is 1,5 m.

** Glassfloat not suitable

- 1 or 2 adjustable limit switches (change over)
- Load: 250 V AC max. , 2 A max. ,
500 VA max.
- Hysteresis: ± 5 % from full scale
- Ambient temperature: -10 °C to +60 °C
- Power supply: 24 V, 110 V, 220 V,
240 V, 50/60 Hz

Reed-contact 60-AMR

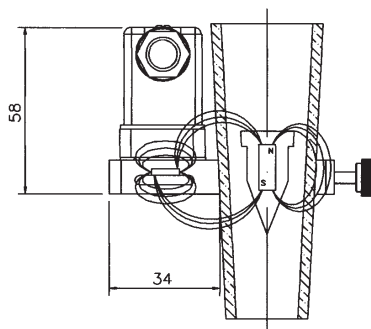

For measuring ranges from 10 - 100 l/h water and 0,17 - 1,7 Nm³/h air

The magnet in the float operates the bi-stable reed-contact (normally open, normally closed)*** in a plastic-box

- 1 or 2 adjustable limit switches
- Switch values: 0,5 A / 250 V DC / 12 VA
- Hysteresis: ± 5 % from full scale
- Ambient temperature: -15 °C to +60 °C
- Power supply: 220 V AC, load: 1 A
24 V DC, load: 1 A

*** Please specify an your order !



Options

Analog transmitter 60-TMUR 0...4 - 20 mA

For measuring ranges from 40 - 400 l/h water and 0,7 - 7 Nm³/h air

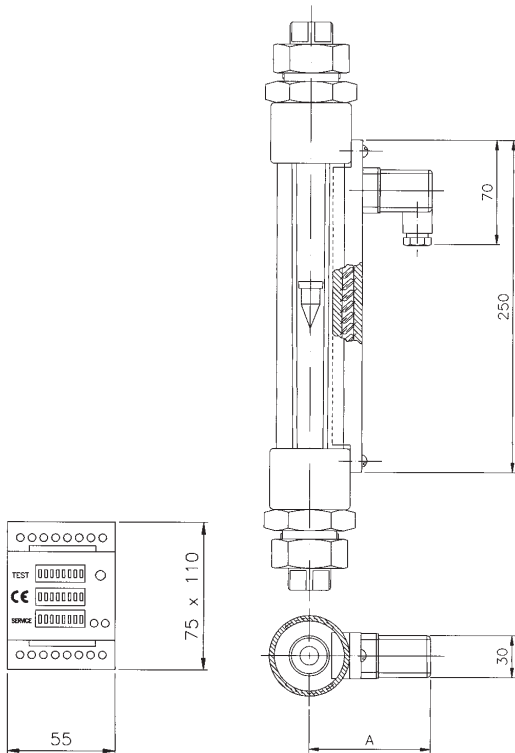

Attached to the body of the flow monitor is a movable plastic case fitted with an integrated reed switch. The electrical wiring is contained in a separate IP 40 housing (DIN 46277).

- Power supply: 24, 110, 220 V AC 50 - 60 Hz
24 V DC
- Output: 0 - 20 mA, 4 - 20 mA
0 - 5 V, 0 - 10 V
- Electrical connection: 4-wire system
- Number of steps: max. 18 steps on the full range
- Accuracy: $\pm 7\%$ from full scale
- Ambient temperature: -20 °C to +70 °C

Dimensions of 60-TMUR

DN	A
15 - 20	80
20 - 25	85
40	101
50	107
65 - 80	120